



CARE INSTRUCTIONS

Daily cleaning can be done by wiping the frame with a clean dry cloth. Should the surface need more attention this can be cleaned with water and a light detergent or soap applied with a damp cloth. Wipe after with a clean dry cloth. Avoid any abrasive materials.

TROUBLESHOOTING

If lamp does not light, turn off the power. Check the bulb for a broken filament. Replace bulb if necessary, then turn it on. If the lamp still does not light, please contact customer service at the local dealer. If the external flexible cable or cord of this lamp is damaged, it must be replaced by a qualified electrician in order to avoid a hazard.

TECHNICAL INFORMATION

Light sources: 3x E26, 810 Lumen
(≤ 60W Incandescent, ≤46W Halogen, ~8-10W LED Dimmable).
Turn power off when changing light bulb. Isolation class II. The lamp is not approved for outdoor use or use in damp/wet rooms (IP20).

SAFETY INSTRUCTIONS

SAFETY INSTRUCTIONS PERTAINING TO RISK OF FIRE,
ELECTRIC SHOCK, OR PERSONAL INJURY!

WARNING: Lighted bulb gets HOT! Do not touch while on.

CAUTION: Keep lamp away from curtains, bedding linens, and any other flammable materials. Do not look directly at lighted bulb. Turn off / unplug and allow lamp to cool before replacing bulb, cleaning or other maintenance. Do not use in the bathroom or damp places.

CAUTION: TO REDUCE THE RISK OF FIRE, USE ONLY TYPE A BULB,
MAX. 3x 60 WATT, E26, 120V 60Hz AC ONLY.

Do not exceed recommended wattage.

CAUTION! IMPORTANT: LAMP MUST BE INSTALLED
BY A QUALIFIED ELECTRICIAN!



For enquiries contact GUBI A/S - CVR: 17940384
Klubiensvej 7-9. 2150 Nordhavn. Copenhagen, Denmark

T +45 69 15 60 60 – order@gubi.com

GUBI.COM

64-20-003-01 Assembly Instructions 1965 Pendant US.

GUBI

ASSEMBLY INSTRUCTIONS

for

1965 Pendant

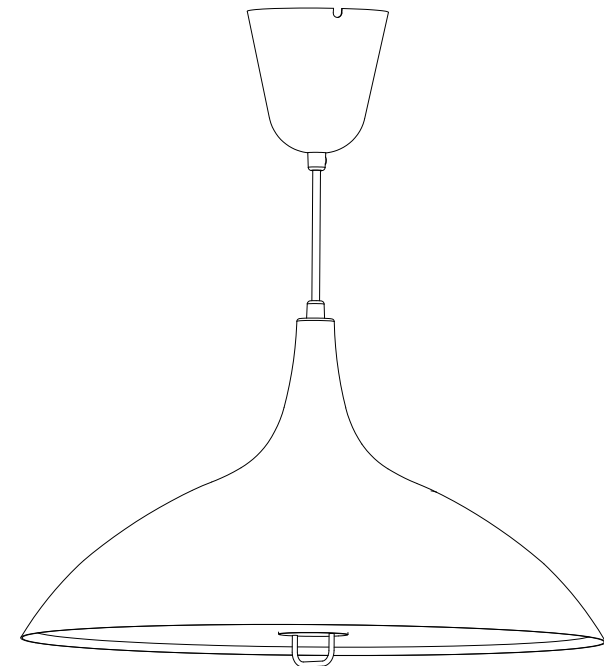

GUBI

ASSEMBLY INSTRUCTIONS

CONTENTS

1965 Pendant

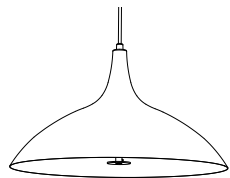

x1

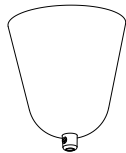

x1

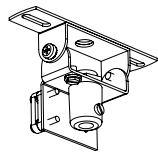

x1

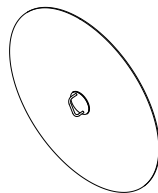

x1



x3

1.

Attach ceiling bracket to the built-in outlet or directly on the ceiling with proper screws.

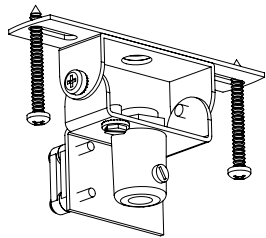

2.

Pull cable through the canopy.

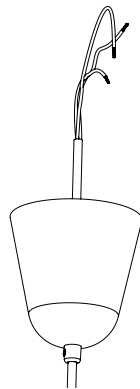

3.

Pull the cable through the cable clamp in the ceiling bracket.

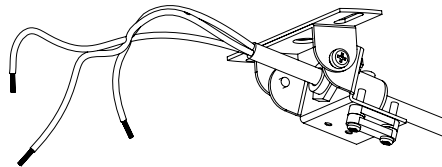

4.

When the right height for the pendant has been found lock the side screw on the cable clamp (A).

If connecting to mains outside the canopy connect pendant directly to the outlet (B).

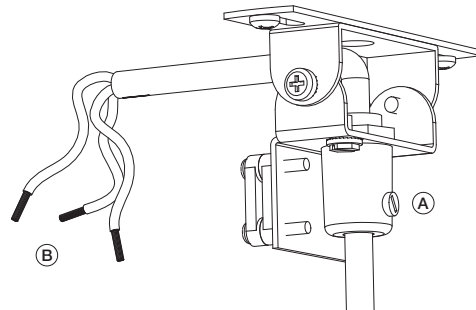

5.

Or cut lamp cable off and connect to the mains cables with the screw terminals. Remember to connect all grounding wires.

Do not forget to secure the mains cable in the cable clamp (A).

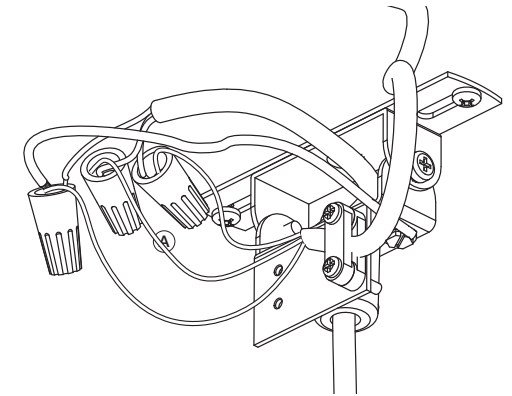

6.

Slide the canopy up the cable and push it against the ceiling while securing it with the side screw (A).

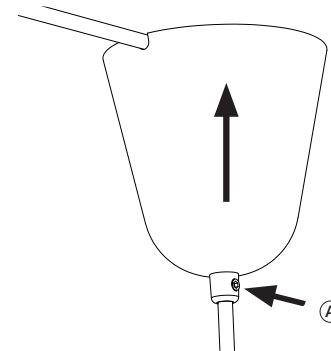

7.

Insert light bulbs in the lamp.

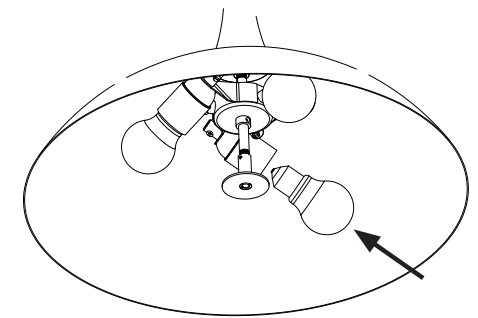

8.

Lift the glass disc with two hands and place it in the center of the lamp. You will hear a click when the glass is in place.

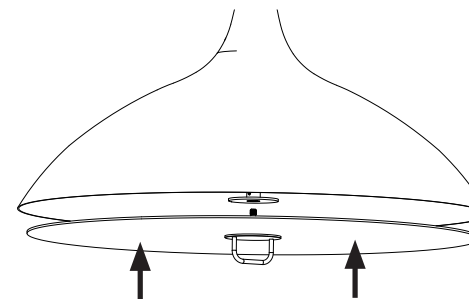

9.

Turn the center handle to secure the glass disc to the lamp.

DO NOT tighten too much as this will break the glass disc.

