

## INSTALLATION INSTRUCTION

### MARIMBA

PD-52718



MODERN FORMS  
A WAC LIGHTING COMPANY

#### WARNING

IMPORTANT: NEVER attempt any work without shutting off the electricity.

- Read all instructions before installing.
- System is intended for installation by a qualified electrician in accordance with the National Electrical Code and local regulations.
- Go to the main fuse box, or circuit breaker. Place the main power switch in the "OFF" position and unscrew the fuse(s) or switch "OFF" the circuit breaker switch(es) that control the power to the fixture or room that you are working on.
- Place the wall switch in the "OFF" position.

#### CAUTION

- All parts must be used as indicated in these instructions. Do not substitute any parts, leave parts out, or use any parts that are worn out or broken. Failure to follow this instruction could invalidate the ETL/CETL listing of this fixture.  
CAUTION When handling the fixture, do not apply pressure to the LEDs. Hold the fixture by the base only.

#### AVERTISSEMENT

IMPORTANT : Coupez l'électricité avant TOUTE manipulation.

- Lisez toutes les instructions avant d'installer.
- Système est destiné à être installé par un électricien qualifié en conformité avec le code national de l'électricité et les règlements locaux.
- Accédez au panneau central de disjoncteurs ou de fusibles de votre demeure et placez l'interrupteur principal en position d'arrêt (« OFF »).
- Placez l'interrupteur mural en position d'arrêt (« OFF »).

#### MISE EN GARDE

- Toutes les pièces doivent être utilisées tel qu'il est indiqué dans ces instructions. Ne remplacez pas les pièces, n'en laissez pas de côté et ne les utilisez pas si elles sont usées ou brisées. Le non-respect de ces instructions peut annuler l'homologation ETL/CETL du luminaire. MISE EN GARDE Ors de la manipulation de l'appareil, ne pas appliquer de pression à la LED, tenir l'appareil par la seule base.

#### ADVERTENCIA

IMPORTANTE: NUNCA intente hacer trabajos sin desconectar el suministro eléctrico.

- Lea y comprenda todas las instrucciones e ilustraciones por completo antes de proceder con el ensamblaje e instalación de esta lámpara.
- Sistema está diseñado para ser instalado por un electricista calificado, de acuerdo con el código eléctrico nacional y las normas locales.
- Diríjase a la caja de fusibles o a la caja del interruptor de circuito principal en su hogar. Coloque el interruptor de alimentación principal en la posición "OFF" (APAGADO).
- Coloque el interruptor de la pared en la posición "OFF" (APAGADO).

#### PRECAUCIÓN

- Todas las piezas deben usarse como lo indican estas instrucciones. No reemplace las piezas, no omita piezas durante la instalación ni utilice piezas gastadas o rotas. El incumplimiento de esta indicación podría invalidar la calificación ETL/CETL esta lámpara. PRECAUCIÓN Al manipular el aparato, no aplique presión a los LED, mantenga el aparato en la base sólo.

#### HARDWARE

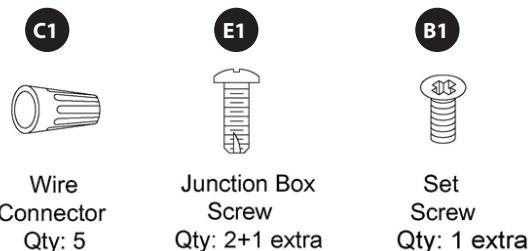

Modernforms  
www.modernforms.com  
Phone (800) 526.2588 • Fax (800) 526.2585

Headquarters/Eastern Distribution Center  
44 Harbor Park Drive • Port Washington, NY 11050  
Phone (516) 515.5000 • Fax (516) 515.5050

Western Distribution Center  
1750 Archibald Ave • Ontario, CA 91761  
Phone (800) 526.2588 • Fax (800) 526.2585

INSTALLATION INSTRUCTION  
**MARIMBA**  
 PD-52718



**PREPARATION**

1. Shut off the power at the circuit breaker and remove existing fixture, including the mounting hardware.

2. Carefully unpack your new fixture and lay out all the parts on a clear area. Be careful not to lose any small parts necessary for installation.

**MOUNTING THE FIXTURE (FIG.1)**

3. Secure the mounting plate (D1) to the junction box (A1) using junction box screw (E1). The side of the mounting plate marked "GND" must face out.

4. Adjust the fixture wire length by pushing the gripper (J1) on the canopy and pulling the wire, as desired. Make sure keeping 3 fixture wires same length and whole fixture is level.

5. Re-set the strain relief near the wiring holes.

**CONNECTING THE WIRES (FIG.2)**

6. Connect the transformer input wires with supply wires as shown in Fig. 2, making sure that all wire connectors (C1) are secured.

7. Cut the fixture wires which marked "24V AC", Keep enough length at least 6". Connect with the transformer output wires (red). Make sure that all wire connectors are secured. Cut another wire and leave it.

**Notes: The fixture wires are braided two layers. Stripped two layers carefully.**

If your outlet box has a ground wire, connect it to the fixture's ground wire. Otherwise, connect the fixture's ground wire directly to the mounting plate (D1) using the green screw provided. Tuck wires carefully inside the junction box.

8. Align the key holes on the canopy (F1) with the screws (B1) on mounting plate (D1), place the canopy (F1) over the mounting plate (D1). Twist it and tighten the screws (B1).

9. Twist lock the glass diffuser (I1) into the shade (H1).

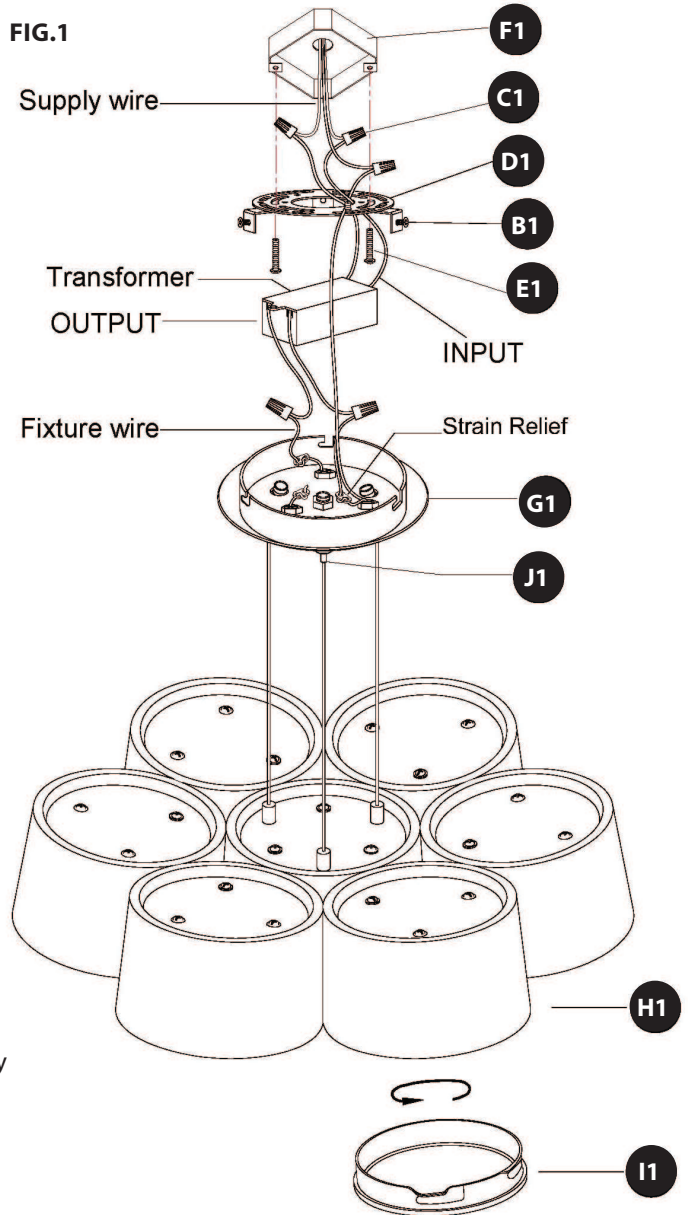

**FIG.2**

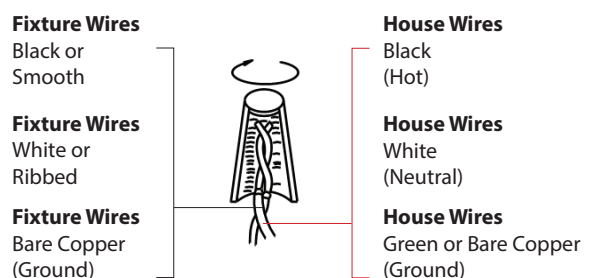

Modernforms  
 www.modernforms.com  
 Phone (800) 526.2588 • Fax (800) 526.2585

Headquarters/Eastern Distribution Center  
 44 Harbor Park Drive • Port Washington, NY 11050  
 Phone (516) 515.5000 • Fax (516) 515.5050

Western Distribution Center  
 1750 Archibald Ave • Ontario, CA 91761  
 Phone (800) 526.2588 • Fax (800) 526.2585

INSTALLATION INSTRUCTION  
**527 - LED Pendant**  
PD-52734

# MODERN FORMS

**CAUTION: To prevent electrical shock, ensure electricity has been turned off at the circuit breaker before beginning.**

- Read all instructions before installing.
- System is intended for installation by a licensed electrician in accordance with the National Electrical Code (NEC) and local regulations.
- When handling the fixture, do not apply pressure to the LEDs. Hold the fixture by the base only.
- Retain installation instructions for future maintenance reference.

**WARNING:** All parts must be used as indicated in these instructions. This product is designed for use only with the supplied parts and/or accessories designated for use by Modern Forms. Substitution of parts or accessories not designated for use with this product by Modern Forms could result in personal injury or property damage, and will void the warranty. Contact an authorized dealer or the manufacturer if any parts are damaged or missing.

**MAINTENANCE NOTE:** Coastal conditions may cause mineral and residue build-up on the fixture. We recommend that customers in coastal areas clean all external surfaces of the fixture once every two weeks with a wet cloth.

**MISE EN GARDE: Pour éviter tout choc électrique, assurez-vous que le disjoncteur soit mis hors tension avant de commencer.**

- Lisez toutes les instructions avant l'installation.
- Le système doit être installé par un électricien licencié conformément au code national de l'électricité (NEC), et également aux règlements locaux.
- Lors de la manipulation du luminaire, n'appuyez pas sur les LED. Tenez-le uniquement par la base.

**ATTENTION:** Toutes les pièces doivent être utilisées comme indiqué dans ces instructions. Ce produit est conçu pour être utilisé seulement avec les pièces et/ou accessoires fournis pour être utilisés avec les produits Modern Forms. Remplacer des pièces ou accessoires non conçus pour ce produit Modern Forms pourrait causer des dommages corporels ou matériels et pourrait également causer l'annulation de la garantie. Veuillez contacter un revendeur autorisé ou le fabricant si des pièces manquent ou sont endommagées.

**NOTE D'ENTRETIEN:** Les conditions côtières peut causer une accumulation de minéraux et de résidus sur le luminaire. Nous recommandons aux clients qui résident dans les zones côtières de nettoyer toutes les surfaces externes du luminaire une fois toutes les deux semaines avec un chiffon humide.

## HARDWARE

A

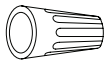

Wire Connector  
Qty: 3 pcs + 1 Extra  
63000122

B



Junction Box Screw  
Qty: 2 pcs + 1 Extra  
7606020251  
#8-32x1  
Zinc Plating

C



Mounting Screw  
Qty: 1 Extra  
7601030151  
5/32-32x5/8  
Nickel Plating

modernforms.com  
Phone (800) 526.2588  
Fax (800) 526.2585

Headquarters/Eastern Distribution Center  
44 Harbor Park Drive  
Port Washington, NY 11050

Central Distribution Center  
1600 Distribution Ct  
Lithia Springs, GA 30122

Western Distribution Center  
1750 Archibald Avenue  
Ontario, CA 91760



INSTALLATION INSTRUCTION  
**527 - LED Pendant**  
 PD-52734

MODERN FORMS

**PREPARATION**

1. Shut off the power at the circuit breaker and remove existing fixture, including the crossbar.
2. Carefully unpack your new fixture and lay out all the parts on a clear area. Be careful not to lose any small parts necessary for installation.

**MOUNTING THE FIXTURE (FIG.1)**

3. Remove the mounting screw (C1) from the fixture.
4. Secure the mounting plate to the junction box using junction box screw (B1). The side of the mounting plate marked "GND" must face out.
5. Loosen the metal ring on the cable gripper, adjust the fixture wire length by pushing the cable gripper on the canopy and pulling the wire as desired. Make sure keeping 3 fixture wires same length and whole fixture is level, fasten the metal ring back to the cable gripper.
  - a. Retract these wires close to a desirable length to within the canopy before securing the fixture in place. Using the cable gripper to adjust more than 18" of wire length is not desirable.
  - b. Warning: Shortening these cables without professional helps or electronic background is not advisable. Any modifications to the fixture will result in voiding the warranty of the product.
6. Re-set the strain relief near the wiring holes.

**CONNECTING THE WIRES (FIG.2)**

7. Connect the transformer input wires with supply wires as shown in Fig. 2, making sure that all wire connectors (C1) are secured. If your outlet box has a ground wire, connect it to the fixture's ground wire. Otherwise, connect the fixture's ground wire directly to the mounting plate (D1) using the green screw provided. Tuck wires carefully inside the junction box.
8. Place the canopy over the mounting plate. Twist it and tighten the mounting screws (C1).
9. Twist lock the glass diffuse into the shade.
10. Please follow these if shortening the wire is needed. Take note or take picture of how the wires are being connected and label each wire clearly. Using the Fig. 3 as given below as reference.

**Fig.1**

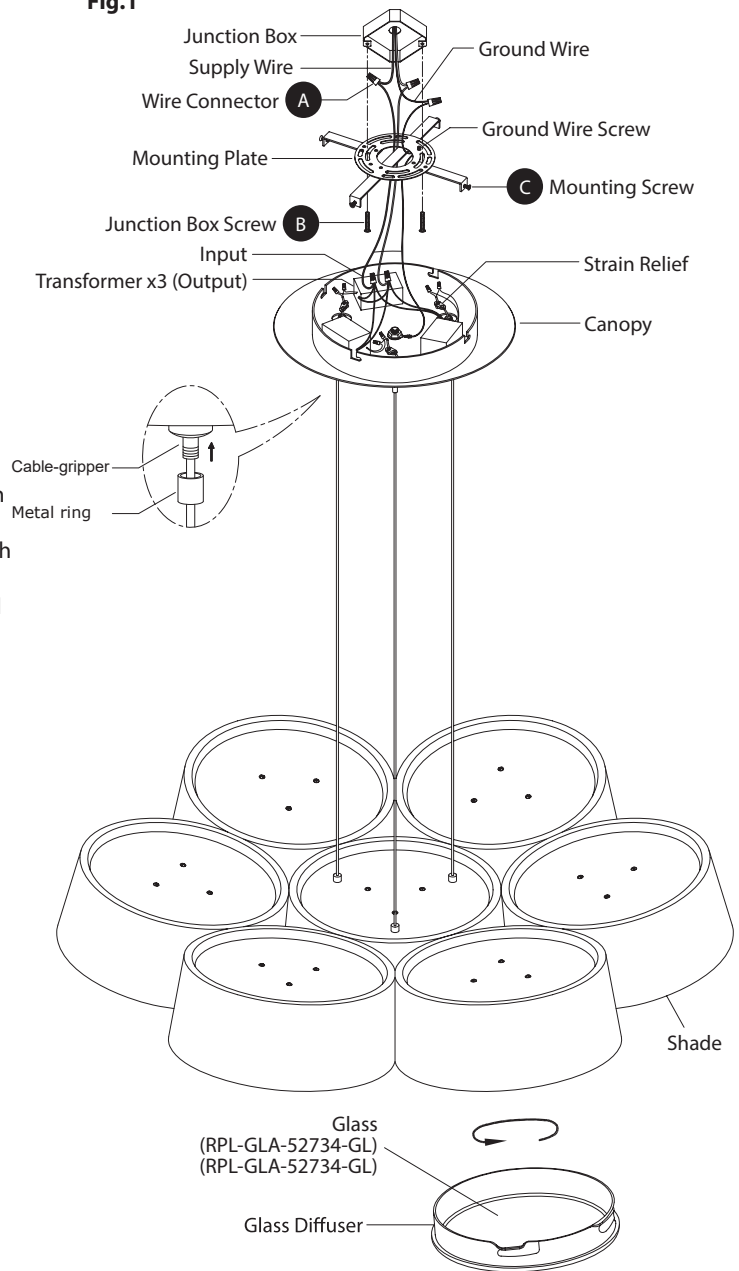

modernforms.com  
 Phone (800) 526.2588  
 Fax (800) 526.2585

Headquarters/Eastern Distribution Center  
 44 Harbor Park Drive  
 Port Washington, NY 11050

Central Distribution Center  
 1600 Distribution Ct  
 Lithia Springs, GA 30122

Western Distribution Center  
 1750 Archibald Avenue  
 Ontario, CA 91760



INSTALLATION INSTRUCTION  
**527 - LED Pendant**  
 PD-52734

# MODERN FORMS

**Back Plate Dimensions**

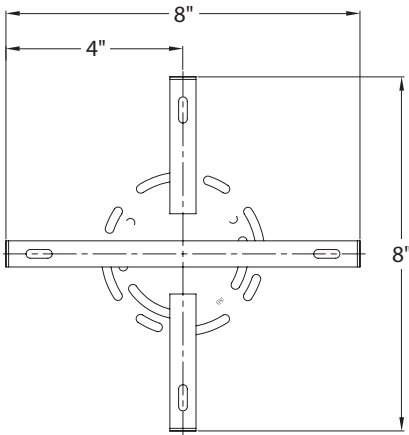

**Fig.2 Wiring**

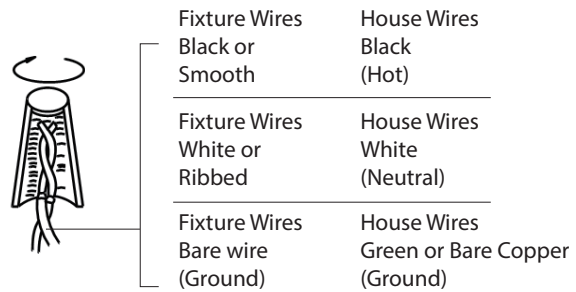

**Fig.3 Diagram**

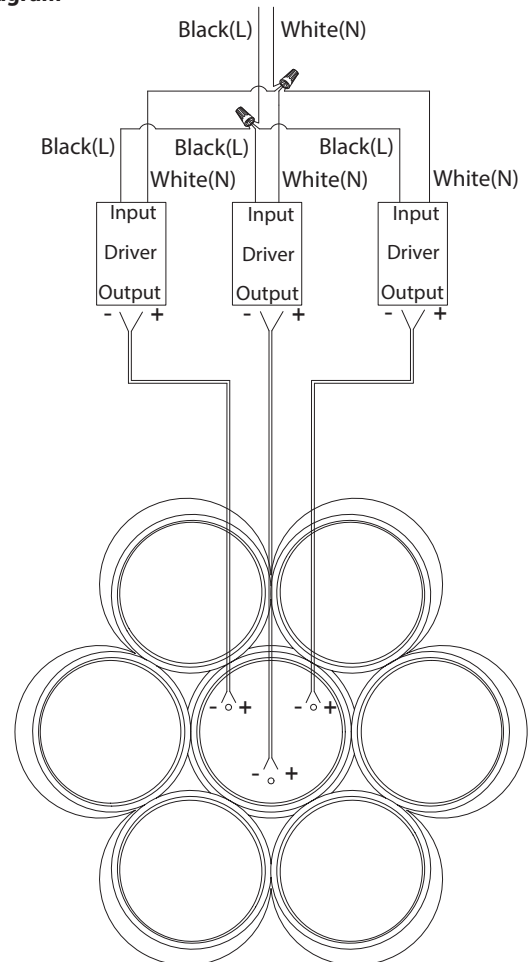

modernforms.com  
 Phone (800) 526.2588  
 Fax (800) 526.2585

Headquarters/Eastern Distribution Center  
 44 Harbor Park Drive  
 Port Washington, NY 11050

Central Distribution Center  
 1600 Distribution Ct  
 Lithia Springs, GA 30122

Western Distribution Center  
 1750 Archibald Avenue  
 Ontario, CA 91760

